

GLASS FLAMES

25 PENDENTS ROUND CHANDELIER

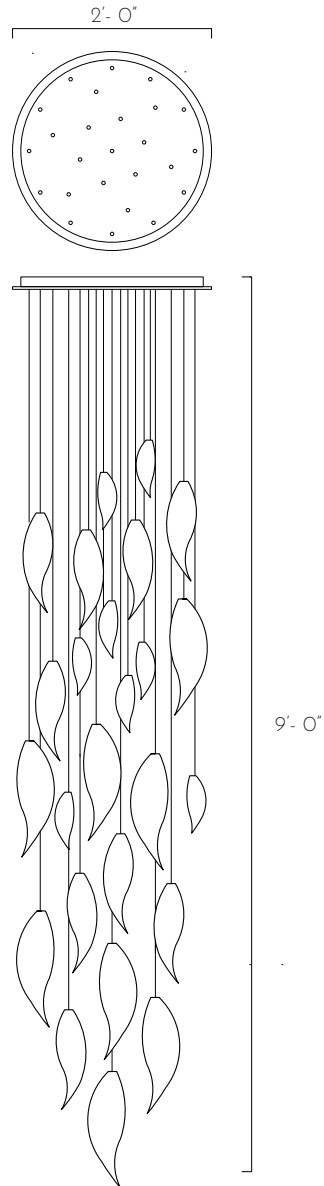

DESCRIPTION

The Glass Flames fixture is a hand-blown glass pendant chandelier designed by AM Studio and Canadian glass artist Karli Sears. Each pendant is hand-blown and finished in an opaque white, opalite, bronze and smoke finish. Perfect as a dining chandelier along the table, a staircase chandelier staggering down from the ceiling, or where an artistic light is needed.

TECHINICAL SPECIFICATIONS

Designed by

Karli Sears & AM Studio

Category

Pendant Chandelier

Canopy Finish

Powder coated metal in Flat White/ Sparkle Silver

Canopy Size

24"D x 1.5"H

Pendant Size

8x units of Large 13"L x 4"D
9x units of Medium 11"L x 3.5"D
8x units of Small 8"L x 3"D

Pendant Colour

White, Opalite, Smoke, Bronze

Total Drop

9'H + 2' extra wire for adjustment

Bulb

Dimmable G4 LED - 2W - 12V

Recommended Dimming Switch

Lutron CTCL-153PD
Lutron Pro

Transformer:

Magnitude E60R12DC - 60W 12VDC - Dimmable - Class 2
LED Driver
Input: 120V
Output: 12V

Electrical Outlet needed: 1

Catalogue # GF-25-24D

Note: Due to the nature of our handmade work, there may be slight variances in glass colour. AM Studio light fixtures are made to order, handmade and created in Toronto, Canada.

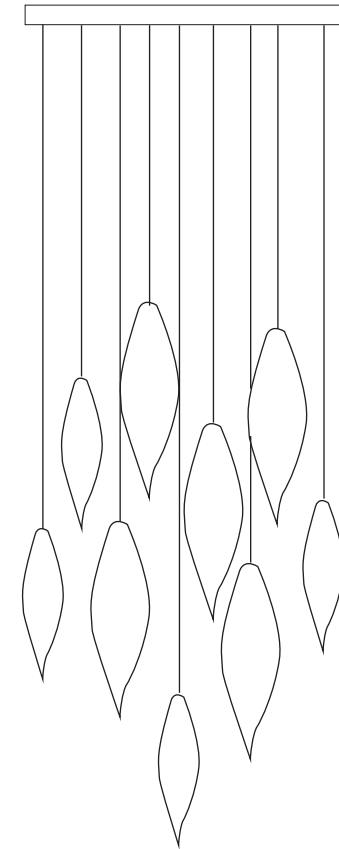
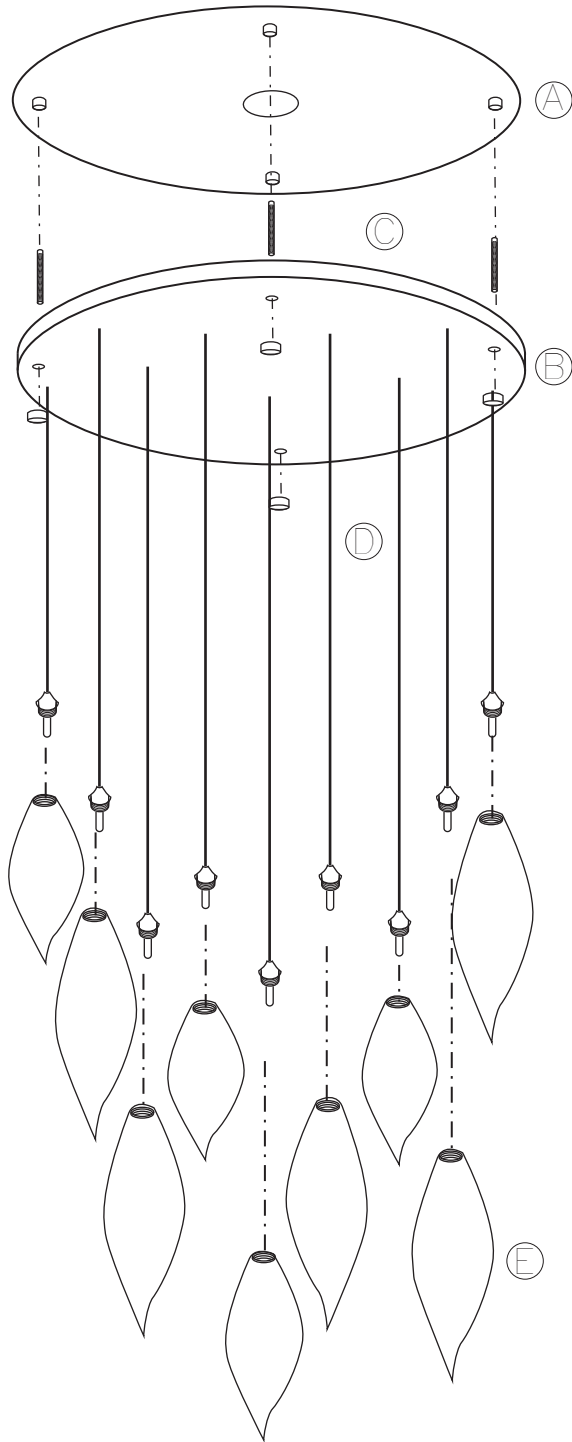

- Ⓐ x1 Bridge
- Ⓑ x1 Base
- Ⓒ x4 Support Rods (temporary mounting only)
- Ⓓ x4 Button Head Screws
- Ⓔ x4 Glass Pendants (three sizes)



1.

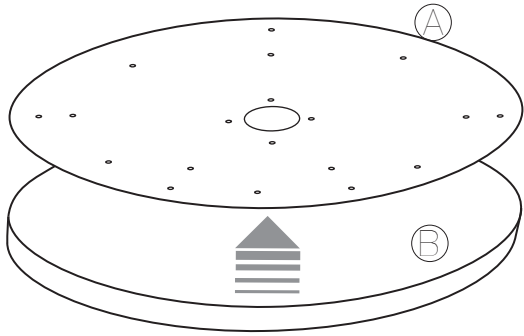

Separate (A) from (B)

2.

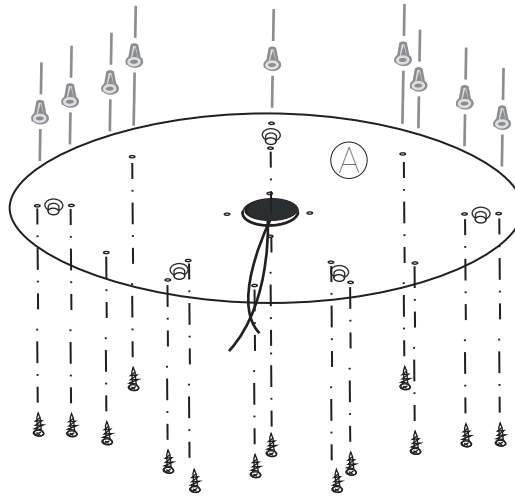

Mount (A) to the ceiling.

Note: When mounting be sure to locate and mount (A) to a joist/ceiling beam

If you cannot do so, be sure to use drywall screws and anchors, drill additional holes for mounting for better support

5.

Test lights by turning on power



Make sure bulb is not touching the glass!

Turn off power after testing

Assembly Guide

3.

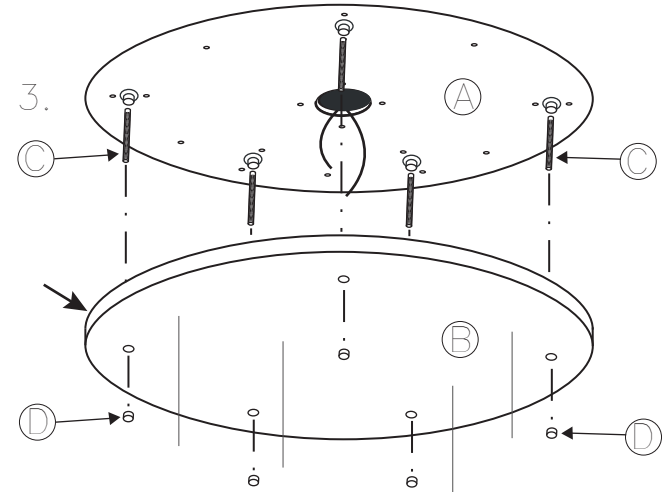

Use support rods (C) provided to hang (B) off of (A)

Complete attachment with button head screws (D)

6.

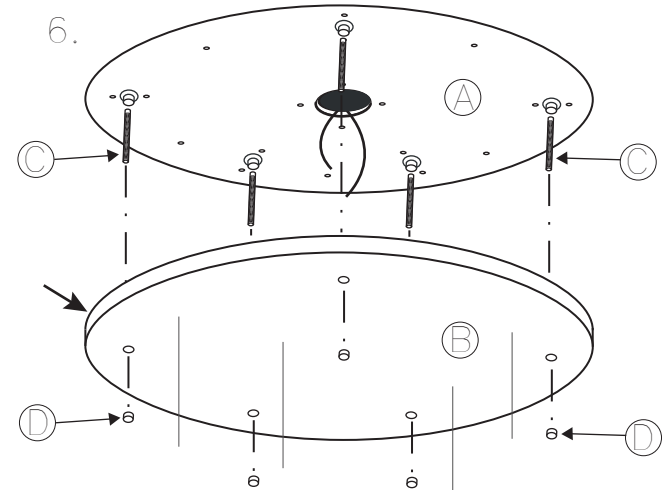

Remove rods and attach (B) to (A) with the button head screws (D)

4.

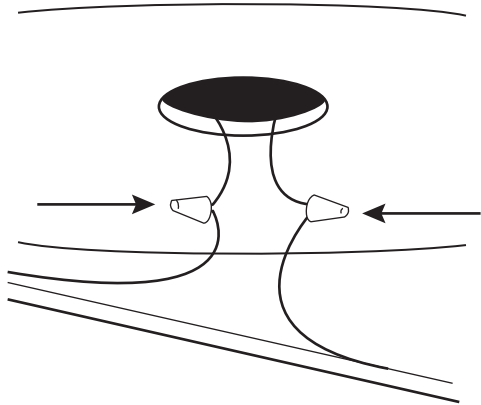

Connect electrical wire to the power

7.

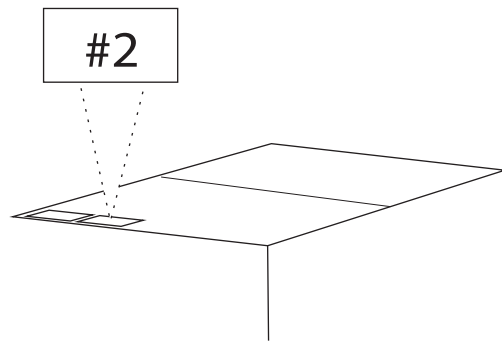

Attach pednants to cables by matching thier stickers

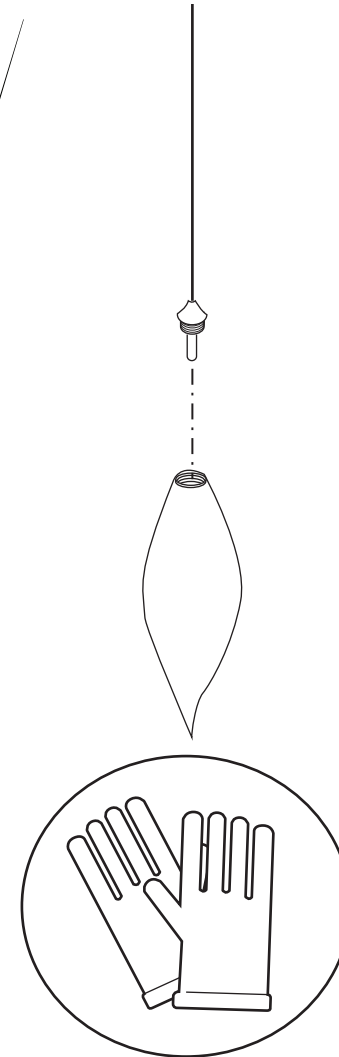
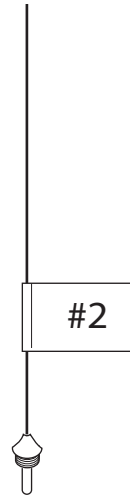

Always use gloves when handling

1.



- Dust the cord/rope/chain with a duster.

2.

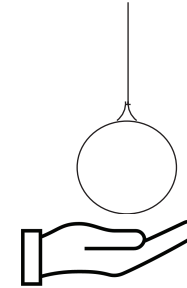

- Hold the glass pendant/light fixture and gently wipe with a duster or microfiber cloth to remove dust.

3.

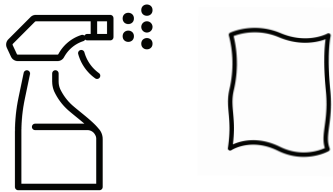

- For spot cleaning, use any good glass cleaner and a microfiber cloth.
⚠ Do **NOT** spray directly onto the light fixture/ glass pendant

4.



- Finish by gently wiping down the pendant with a soft, dry microfibre cloth.

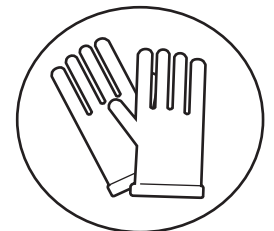

Always use gloves when handling glass